

**Knickschutztüllen KT**

Material: Polychloropren Gummi  
Temperatur: -30 bis +90°C

Farbe: schwarz:  
(Materialspezifikation auf Anfrage)

Typ	Art.-Nr.	VPE	Typ	Art.-Nr.	VPE	Typ	Art.-Nr.	VPE	Typ	Art.-Nr.	VPE
KT 009	56-001	100	KT 329*	56-060	25	KT 608	56-073	100	KT 751	56-091	50
KT 043	56-004	100	KT 354	56-061	100	KT 625	56-219	100	KT 756	56-085	50
KT 045	56-005	100	KT 380	56-062	100	KT 633	56-077	50	KT 760	56-213	100
KT 049	56-008	50	KT 383	56-056	100	KT 642	56-078	100	KT 781	56-087	50
KT 083	56-013	25	KT 391	56-063	100	KT 643	56-079	50	KT 747	56-083	50
KT 130	56-014	50	KT 401	56-201	100	KT 649	56-075	100	KT 806	56-214	100
KT 131	56-015	50	KT 402	56-202	100	KT 651	56-076	100	MB 900	56-144	100
KT 147	56-016	50	KT 403	56-203	100	KT 672	56-092	50	Zugentlastung Metallbride für KT 412 s. Seite 58		
KT 159	56-017	100	KT 405	56-205	100	KT 633	56-077	50	* EPDM Gummi		
KT 164	56-018	50	KT 410	56-051	100	KT 679	56-261	100			
KT 169	56-019	100	KT 411	56-052	50	KT 680	56-095	100			
KT 170	56-020	100	KT 412	56-053	50	KT 691*	56-210	100			
KT 171	56-021	100	KT 538	56-064	100	KT 692*	56-211	50			
KT 172	56-022	100	KT 561	56-065	100	KT 693*	56-212	50			
KT 187	56-208	100	KT 579	56-066	50	KT 721	56-003	100			
KT 190	56-010	100	KT 592	56-070	50	KT 737	56-080	50			
KT 306	56-057	100	KT 595	56-034	100	KT 742	56-263	100			
KT 318	56-058	100	KT 596	56-071	100	KT 747	56-083	50			
KT 320	56-059	25	KT 602*	56-072	50	KT 748	56-084	50			

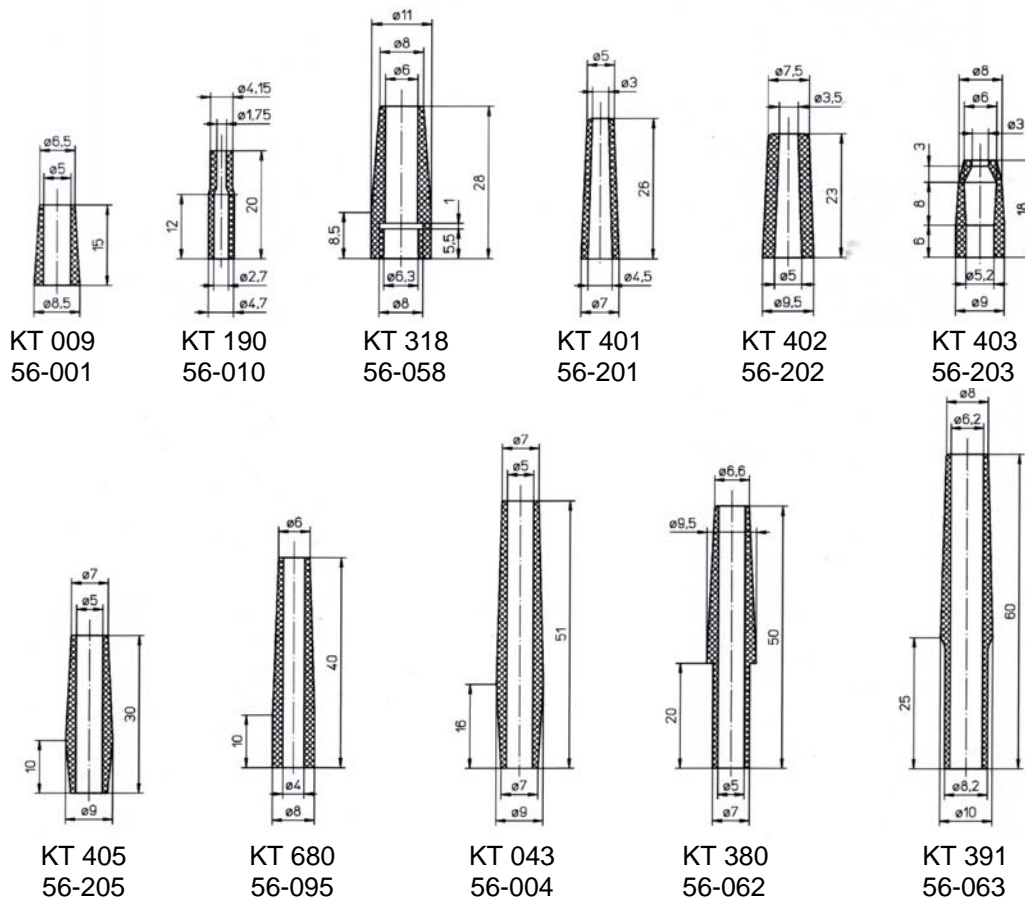

**Knickschutztüllen KT**

Material: Polychloropren Gummi  
Temperatur: -30 bis +90°C

Farbe: schwarz:  
(Materialspezifikation auf Anfrage)

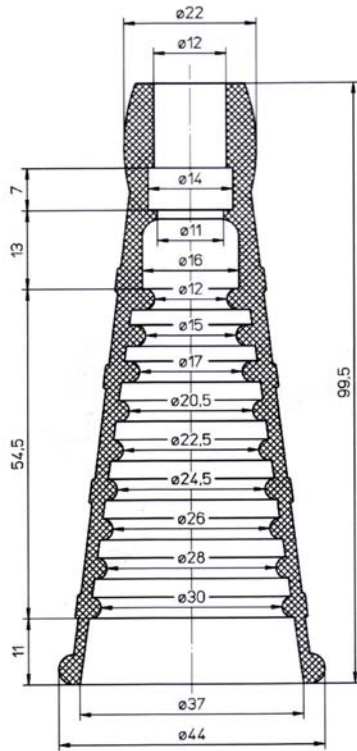

KT 329  
56-060

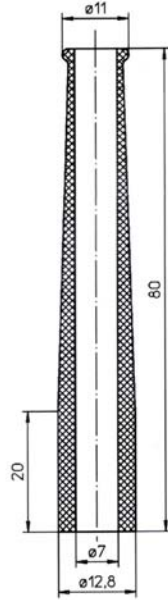

KT 164  
56-018

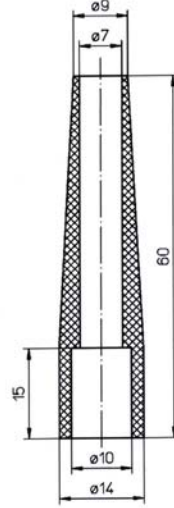

KT 045  
56-005

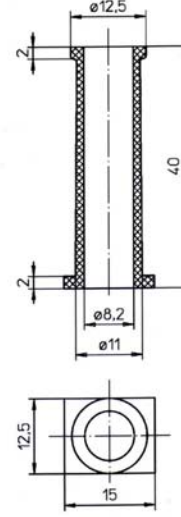

KT 642  
56-078

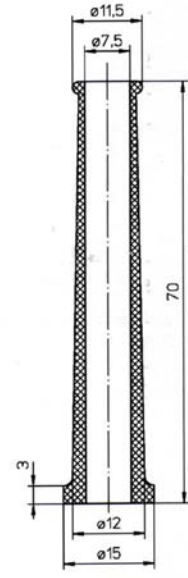

KT 411  
56-052

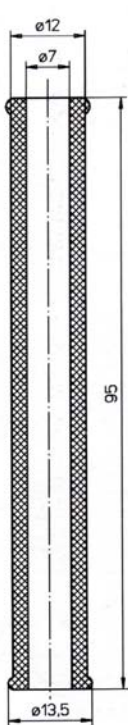

KT 169  
56-019

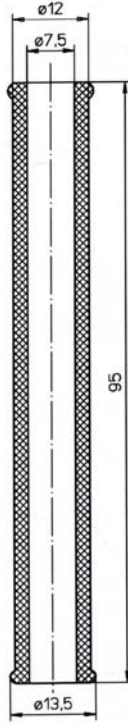

KT 170  
56-020

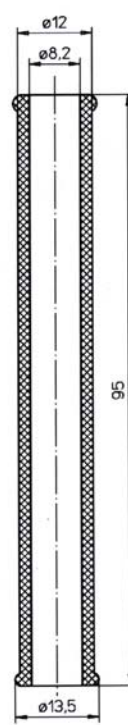

KT 172  
56-021

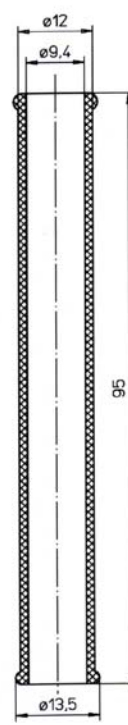

KT 172  
56-022

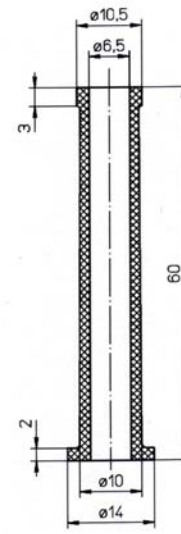

KT 538  
56-064

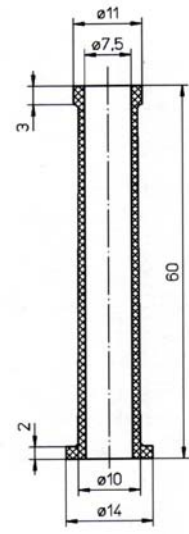

KT 579  
56-066

**Knickschutztüllen KT**

Material: Polychloropren Gummi  
Temperatur: -30 bis +90°C

Farbe: schwarz:  
(Materialspezifikation auf Anfrage)

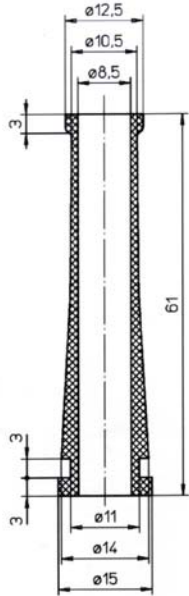

KT 633  
56-077

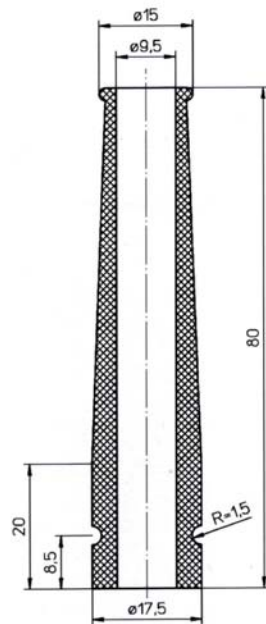

KT 651  
56-076

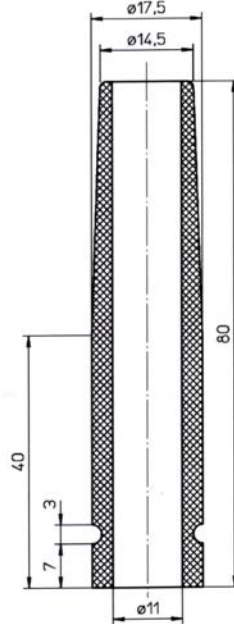

KT 693  
56-212

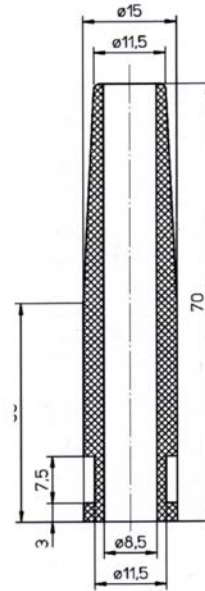

KT 692  
56-211

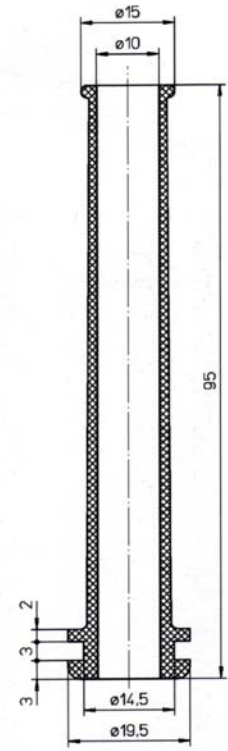

KT 561  
56-065

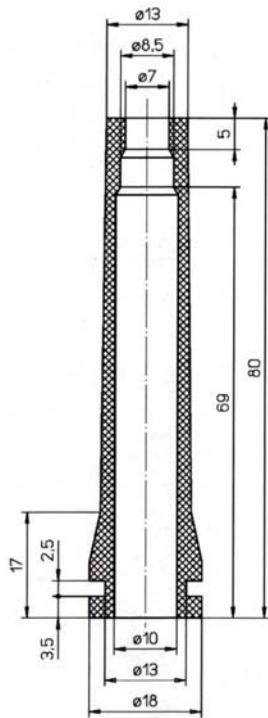

KT 643  
56-079

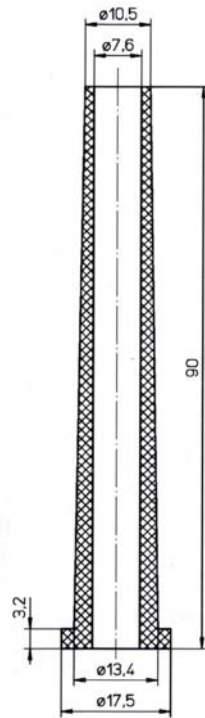

KT 602  
56-072

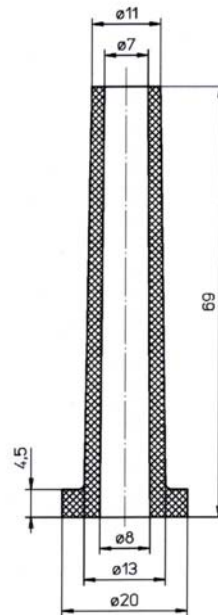

KT 592  
56-070

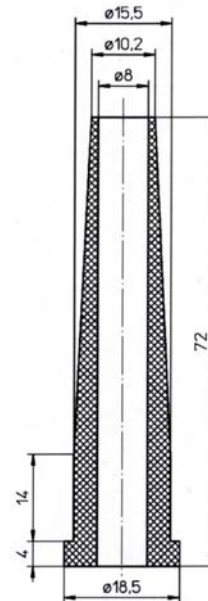

KT 130  
56-014

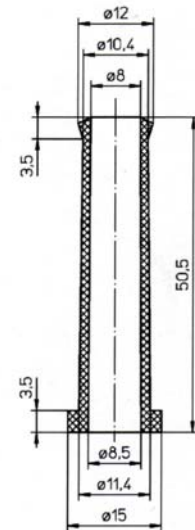

KT 383  
56-056

**Knickschutztüllen KT**

Material: Polychloropren Gummi  
Temperatur: -30 bis +90°C

Farbe: schwarz:  
(Materialspezifikation auf Anfrage)

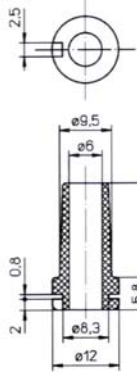

KT 354  
56-061

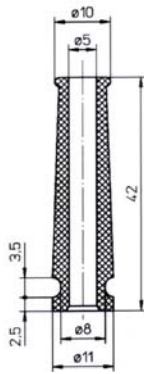

KT 159  
56-017

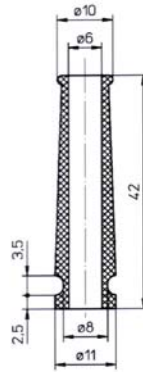

KT 410  
56-051

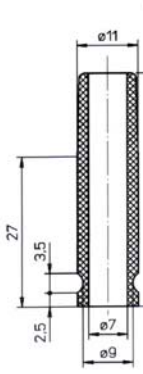

KT 691  
56-210

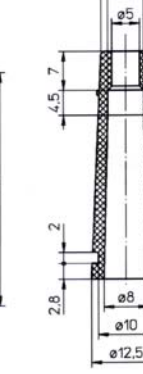

KT 608  
56-073

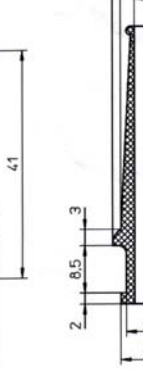

KT 306  
56-057

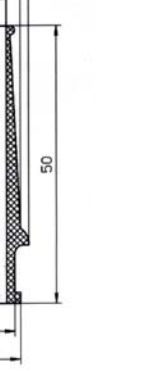

KT 187  
56-208

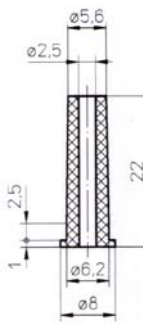

KT 760  
56-213

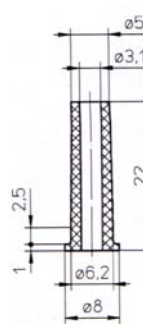

KT 721  
56-003

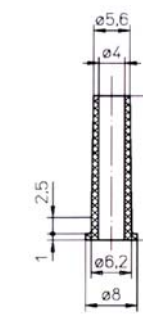

KT 649  
56-075



KT 742  
56-263

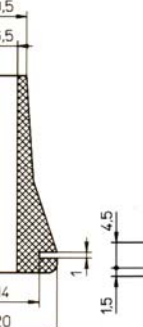

KT 596  
56-071

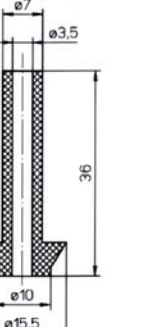

KT 625  
56-219



KT 679  
56-261

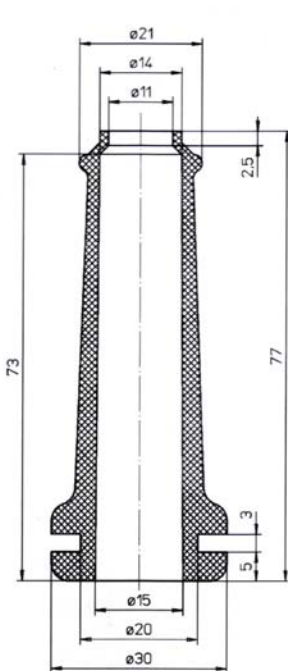

KT 049  
56-008

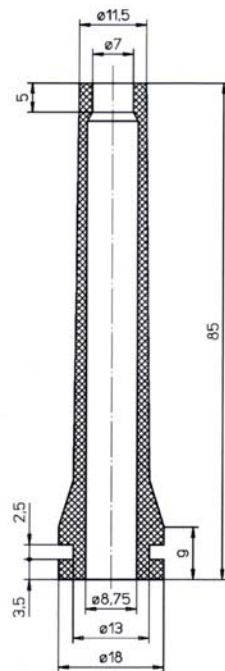

KT 131  
56-015

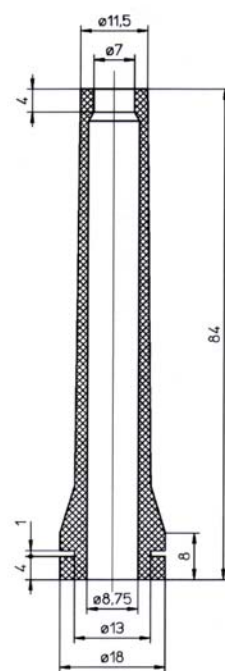

KT 672  
56-092

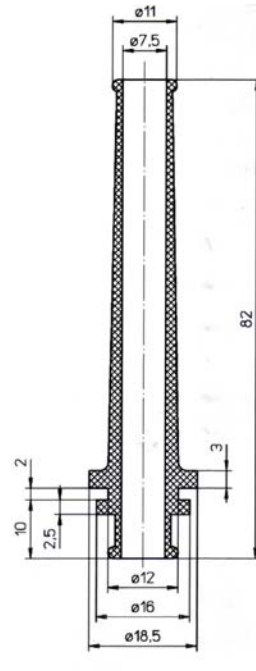

KT 412  
56-053

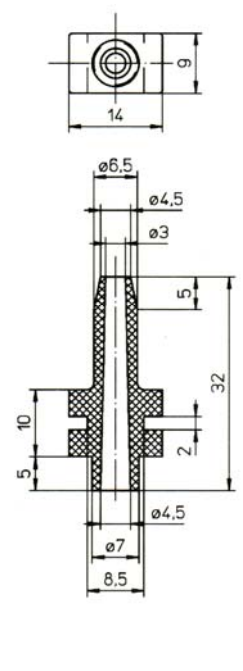

KT 595  
56-034

**Knickschutztüllen KT**

Material: Polychloropren Gummi  
Temperatur: -30 bis +90°C

Farbe: schwarz:  
(Materialspezifikation auf Anfrage)

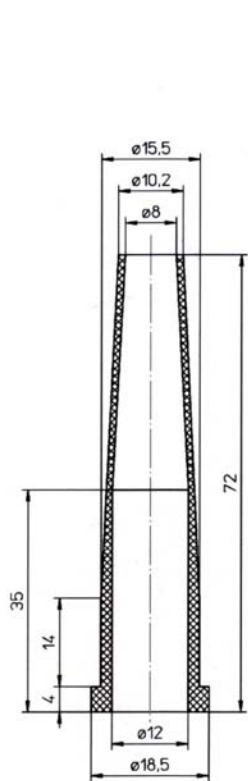

KT 147  
56-016

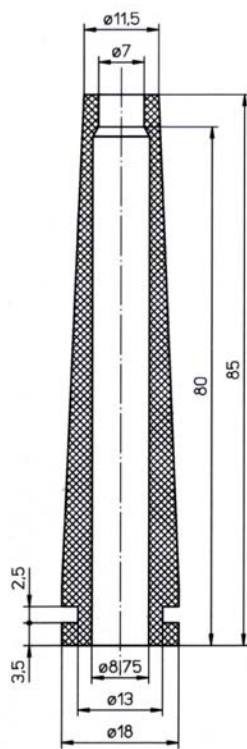

KT 751  
56-091

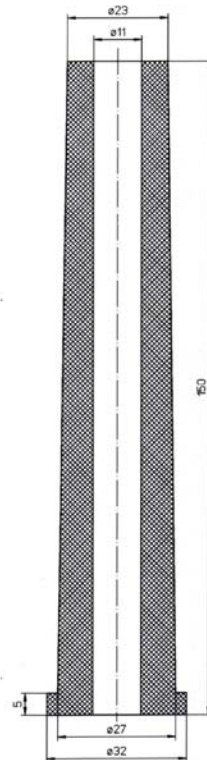

KT 320  
56-059

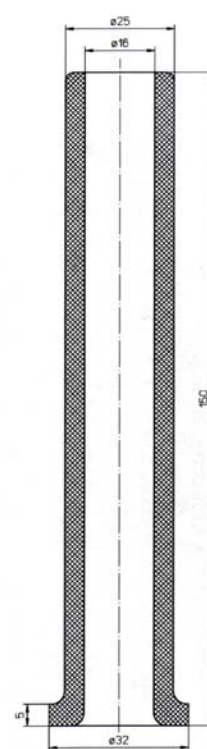

KT 083  
56-013

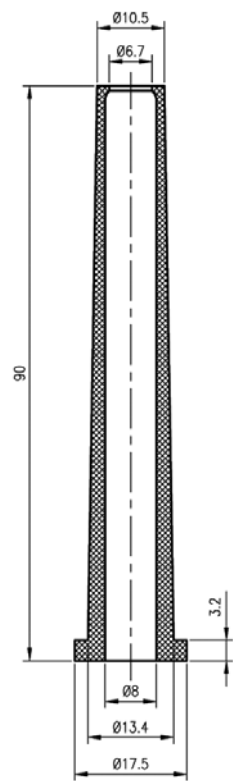

KT 806  
56-214

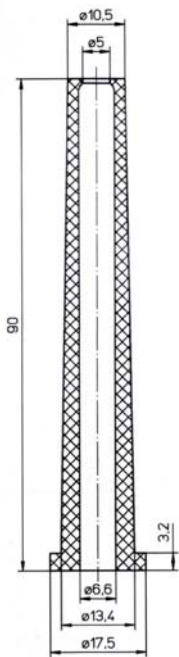

KT 756  
56-085

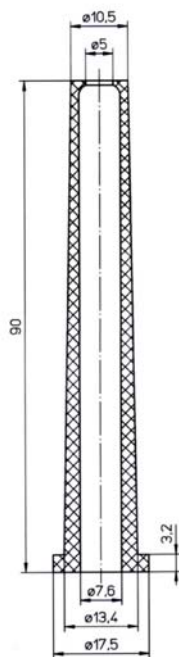

KT 737  
56-080

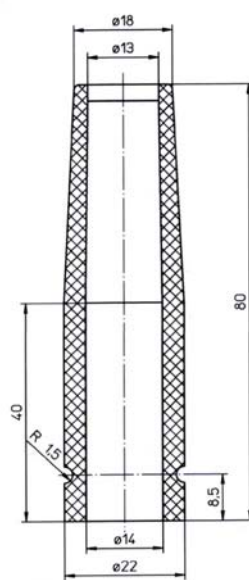

KT 747  
56-083

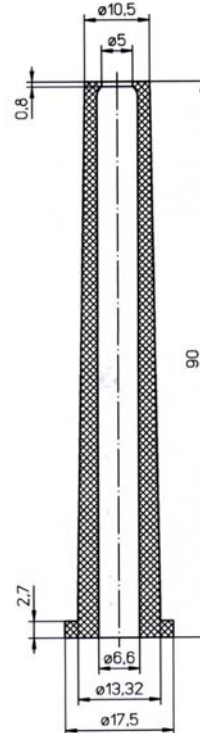

KT 781  
56-087

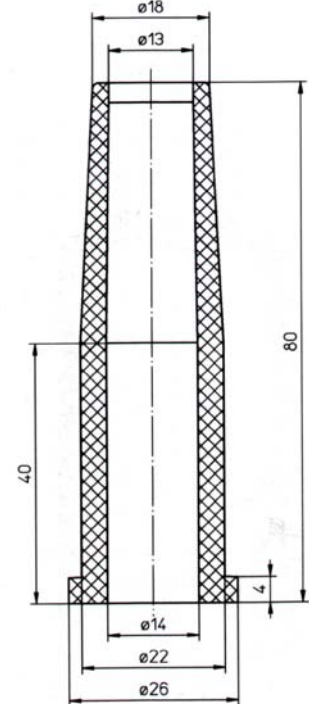

KT 748  
56-084



**Knickschutztüllen KT - TPE**

Material: TPE - thermoplastisches Elastomer  
Temperatur: -50 bis +125°C (+150°C kurzzeitig)

Farbe: schwarz, Härte Shore A: 55 ± 5  
Brandverhalten: UL94 HB (UL-gelistet)  
Reissdehnung: >300%, Durchschlag: 35kV/mm

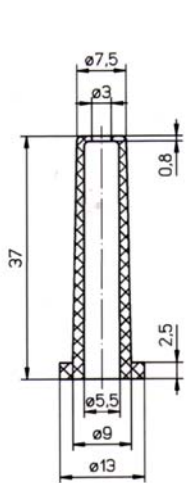

KT-TPE 1462  
56-450

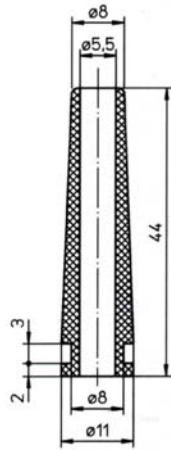

KT-TPE 599  
56-400

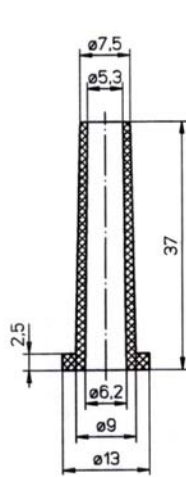

KT-TPE 1466  
56-451

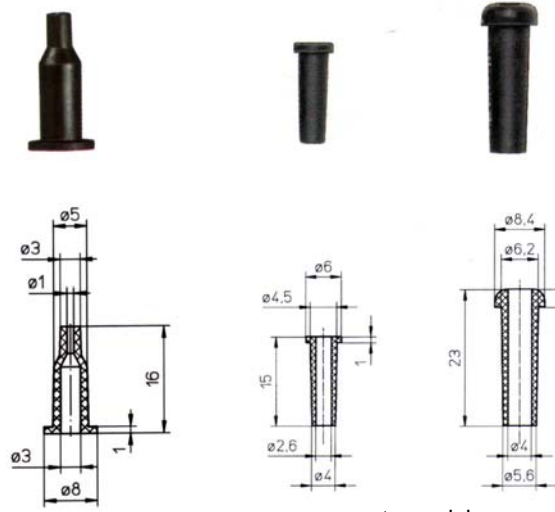

KT-TPE 1460  
56-460

KT-TPE 387  
56-310

KT-TPE 407  
56-320

extra-weich  
-40 bis +70°C



KT-TPE 1017  
56-490

KT-TPE 1431  
56-491

KT-TPE 1428  
56-492

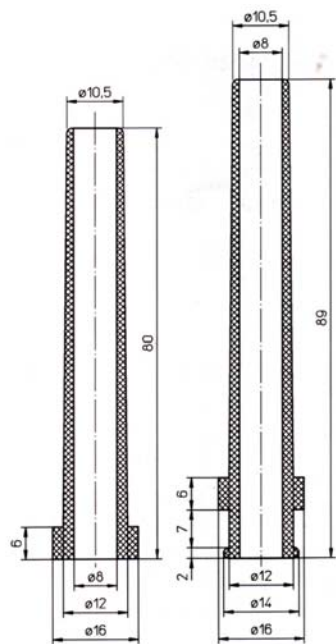

KT-TPE 598  
56-390

KT-TPE 581  
56-360

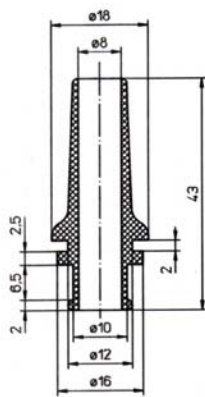

KT-TPE 908  
56-420

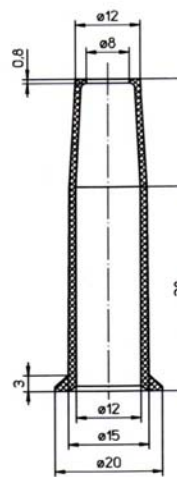

KT-TPE 552  
56-340

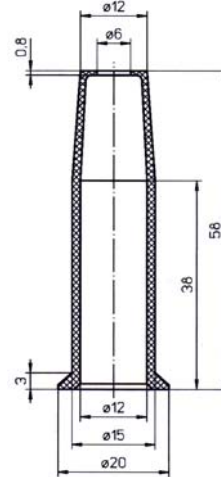

KT-TPE 1584  
56-461

**Knickschutztüllen KT - PVC**

Material: Weich-PVC, schwarz (Farbe weiß auf Anfrage)  
Temperatur: -30 bis +70°C

Härte Shore A: 55 ± 5,  
Brandverhalten: UL94 HB (intern getestet)  
Reissdehnung: 350%, Durchschlag: >20kV/mm

Typ	Art.-Nr.	VPE
KT-PVC 542	56-101	100
KT-PVC 552	56-102	100
KT-PVC 553	56-103	100
KT-PVC 581	56-104	100
KT-PVC 582	56-105	100
KT-PVC 583	56-106	100
KT-PVC 598	56-107	100
KT-PVC 599	56-108	100
KT-PVC 600	56-109	100
KT-PVC 908	56-110	100
KT-PVC 1372	56-111	50
KT-PVC 1374	56-112	100
KT-PVC 1392	56-113	100
KT-PVC 1459	56-116	100
KT-PVC 1462	56-114	100
KT-PVC 1466	56-118	100
KT-PVC 1584	56-119	100
KT-PVC 1017	56-910	100
KT-PVC 1431	56-902	100
KT-PVC 1428	56-951	100
KT-PVC 8-17/20-1,6	55-720	200
MB 900	56-144	100

Zugentlastung Metallbride

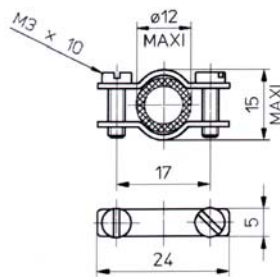

Metallbride für Knickschutztüllen.  
Zugentlastung für folgende  
Artikel:  
KT 542; KT 582; KT 583; KT 908, KT 412

MB 900  
56-144

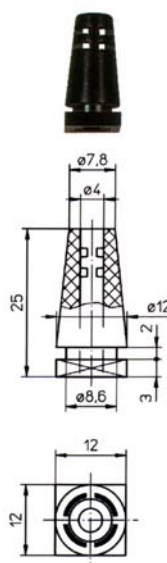

KT-PVC 1392  
56-113

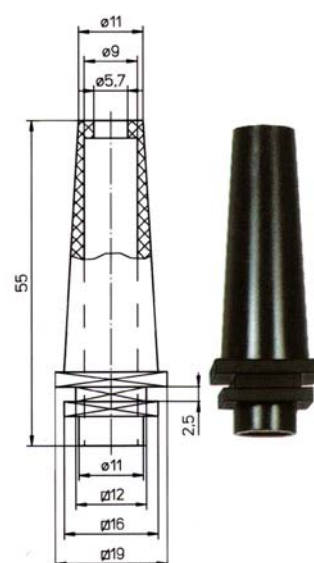

KT-PVC 1372  
56-111

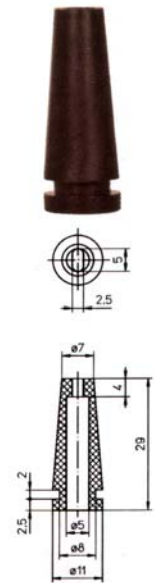

KT-PVC 1374  
56-112

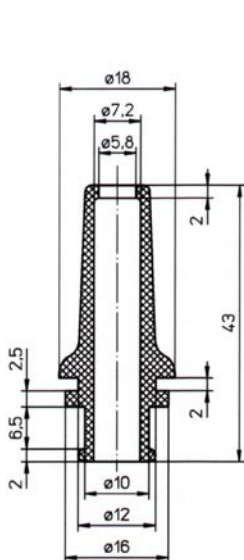

KT-PVC 542  
56-101

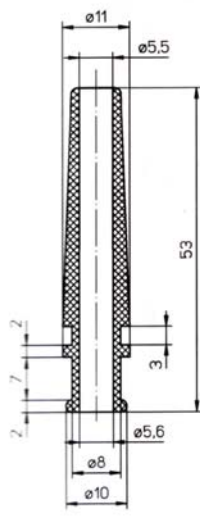

KT-PVC 582  
56-105

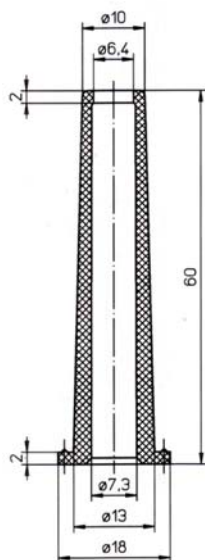

KT-PVC 1459  
56-116

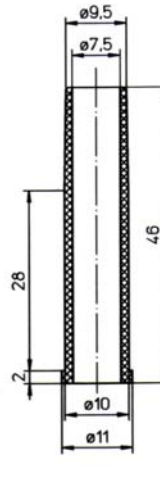

KT-PVC 553  
56-103

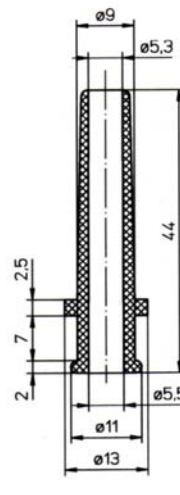

KT-PVC 583  
56-106

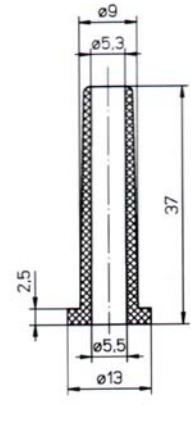

KT-PVC 600  
56-109

**Knickschutztüllen KT - PVC**

Material: Weich-PVC, schwarz (Farbe weiß auf Anfrage)  
Temperatur: -30 bis +70°C

Härte Shore A: 55 ± 5,  
Brandverhalten: UL94 HB (intern getestet)  
Reissdehnung: 350%, Durchschlag: >20kV/mm

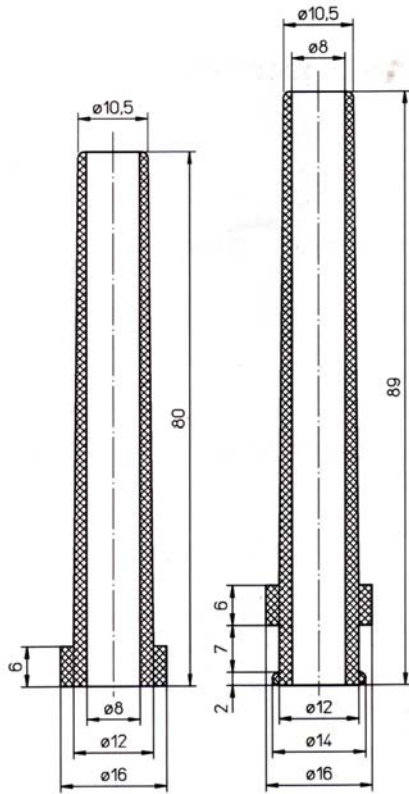

KT-PVC 598  
56-107

KT-PVC 581  
56-104

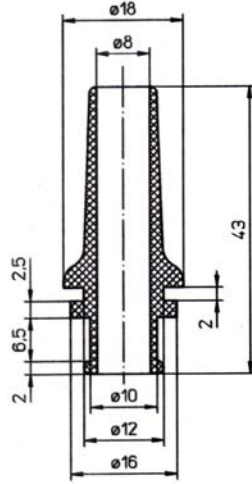

KT-PVC 908  
56-110

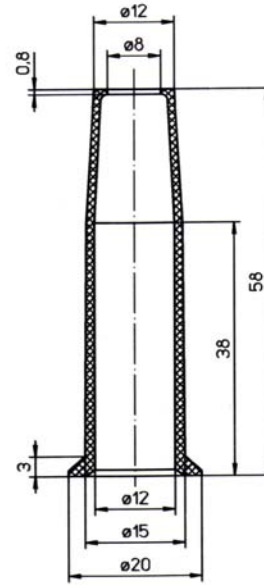

KT-PVC 552  
56-102

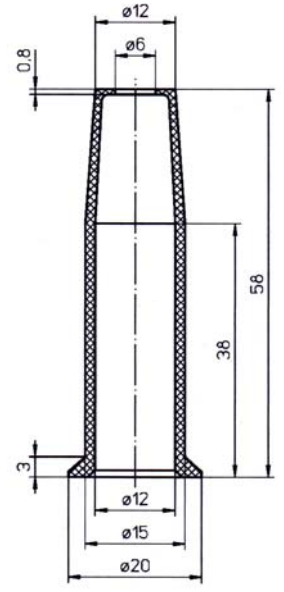

KT-PVC 1584  
56-119

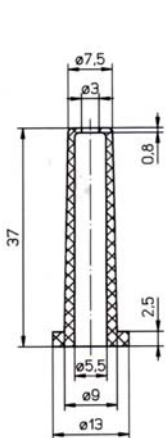

KT-PVC 1462  
56-114

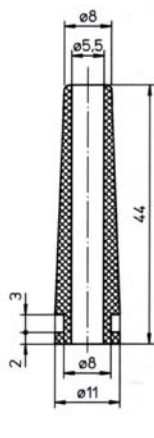

KT-PVC 599  
56-108

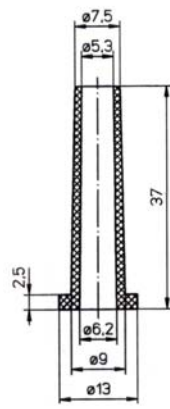

KT-PVC 1466  
56-118

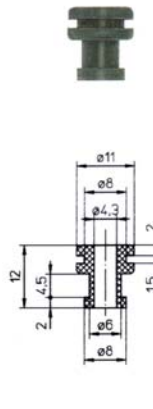

KT-PVC 1017  
56-910

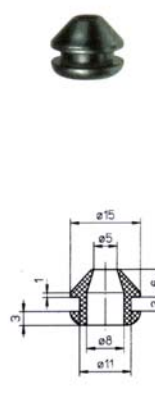

KT-PVC 1431  
56-902

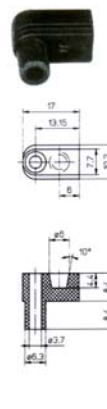

KT-PVC 1428  
56-951



KT-PVC 8-17/20-1,6  
55-720